

Kinghelm®

ISSUE	DESCRIPTION	DWN	DATE	APPROVEN
A	First issue	Gavin	2022/06/15	JIM. KING

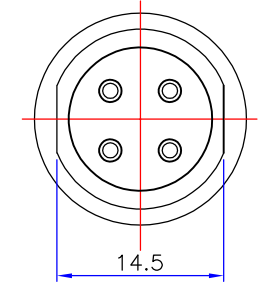
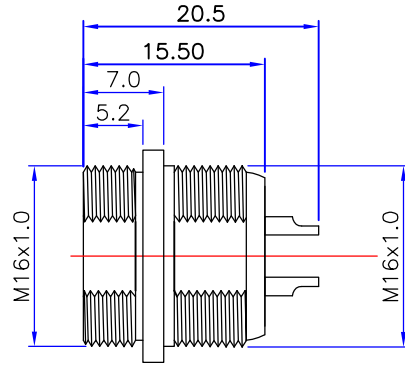
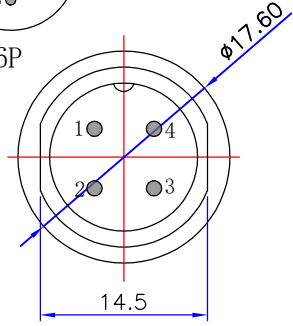
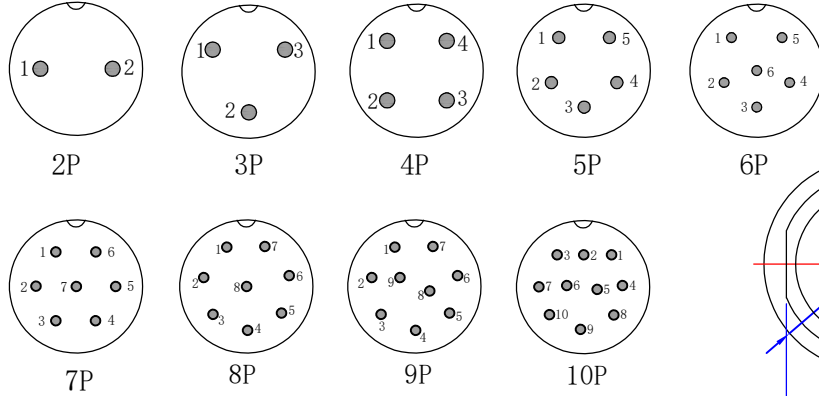

Material and specifications

- Coupling Threaded coupling
- Shell material Zinc alloy with Nickel Plate
- Insert material bakelite
- Contact material copper Silver Plate/Nickel
- Termination Solder
- Mating cycle 500
- Cable diameter -20°C $+85^{\circ}\text{C}$

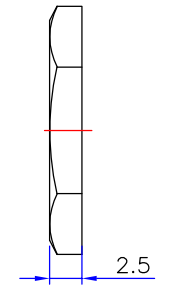
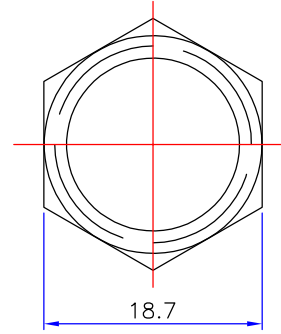
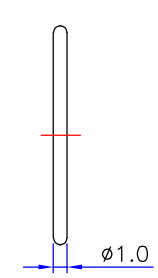
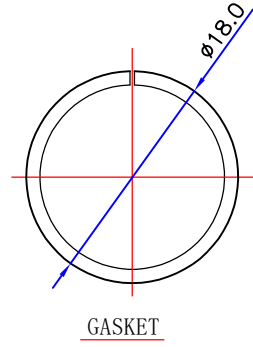

Technology parameter									
NO.of contacts	2	3	4	5	6	7	8	9	10
Rated current (A)	7	7	7	7	5	5	5	5	5
Operation limit voltage(AC.V.rms)	220	220	125	125	125	125	125	125	125
Withstanding voltage(AC.V.rms) 1 minute	1500	1500	1500	1500	1500	1500	1500	1500	1500
Insulation resistance (mΩ)	2000	2000	2000	2000	2000	2000	2000	2000	2000
Contact resistance (mΩ)	5	5	5	5	5	5	5	5	5
Solder cup mouth aperture	$\phi 1.4$	$\phi 1.4$	$\phi 1.4$	$\phi 1.2$	$\phi 0.8$	$\phi 0.8$	$\phi 0.8$	$\phi 0.8$	$\phi 0.8$
Solder inter diameter	$\phi 2.5$	$\phi 2.5$	$\phi 2.5$	$\phi 2.0$	$\phi 1.2$	$\phi 1.2$	$\phi 1.2$	$\phi 1.2$	$\phi 1.2$

-TOLERANCES- UNLESS OTHERWISE SPECIFIED	深圳市金航标电子有限公司		www.kinghelm.com.cn			
	SHENZHEN KINGHELM ELECTRON CO.,LTD.		0755-28190160			
UNLESS OTHERWISE SPECIFIED TOLERANCES FOR MILLIMETERS ARE: 0.5 - 8mm ± 0.20mm 8 - 30mm ± 0.25mm 30 - 120mm ± 0.30mm	PART DESCRIPTION: GX16 MALE CONNECTOR					
	Appr: JIM. KING	P/N: KH-GX16-6P				
	Check:	Date	Scale	Unit	Type	Page
	Draw: Gavin	2022.06.15	Free	MM	Z	1/1

REV	DESCRIPTION	DWN	DATE	APPROVEN
A	FIRST ISSUE	XIEFENG	2022/06/15	Mr.chen

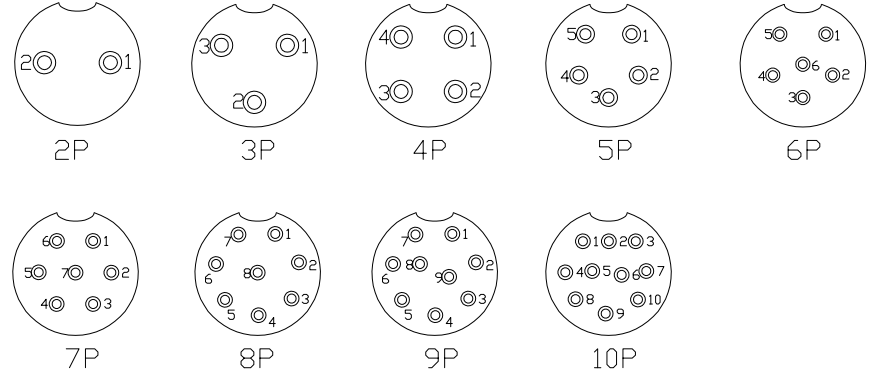
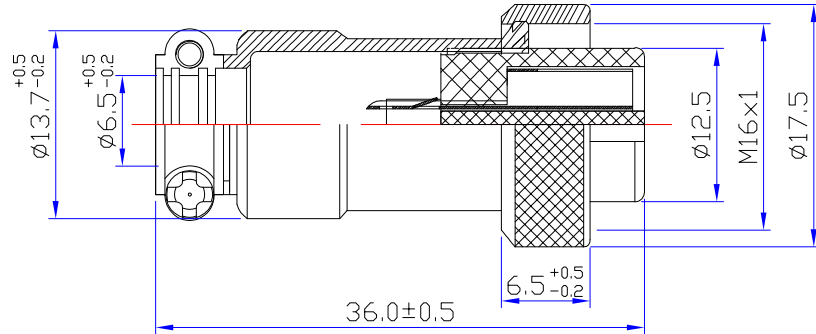

Material and specifications

- Coupling Threaded coupling
- Shell material Zinc alloy with Nickel Plate
- Insert material bakelite
- Contact material copper Silver Plate/Nickel
- Termination Solder
- Mating cycle 500
- Cable diameter -20℃ +85℃

Technology parameter									
NO. of contacts	2	3	4	5	6	7	8	9	10
Rated current (A)	7	7	7	7	5	5	5	5	5
Operation limit voltage(AC.V.rms)	220	220	125	125	125	125	125	125	125
Withstanding voltage(AC.V.rms) I minute	1500	1500	1500	1500	1500	1500	1500	1500	1500
Insulation resistance (mΩ)	2000	2000	2000	2000	2000	2000	2000	2000	2000
Contact resistance (mΩ)	3	3	3	4	5	5	4	5	5
Solder cup mouth aperture	φ1.4	φ1.4	φ1.4	φ1.2	φ0.8	φ0.8	φ0.8	φ0.8	φ0.8
Solder inter diameter	φ2.5	φ2.5	φ2.5	φ2.0	φ1.2	φ1.2	φ1.2	φ1.2	φ1.2

NOTE:		Tolerance	UNLESS OTHERWISE SPECIFIED TOLERANCES FOR DIMENSIONS ARE 0.5-8MM±0.10MM 8-30MM±0.15MM 30-120MM±0.20MM	深圳市金航标电子有限公司		www.kinghelm.com.cn	
DRAWN: XIEFENG	DATE: 22/06/15			SHENZHEN KINGHELM ELECTRON CO.,LTD.		0755-28190160	
CHECKED:		VIEW		Name: GX16 FEMALE CONNECTOR			
APPROVALS:		UNIT	MM	Product NO. KH-GX16-6P			REV A
		SCALE	1 : 1	CAD FILE H/companydrawings/BD			SHEET: 1 OF 1