

REV	ECN NO.	DESCRIPTION	DATE	APP'D
A/0		RELEASE TO PRODUCTION	01/10/18'	Scrth

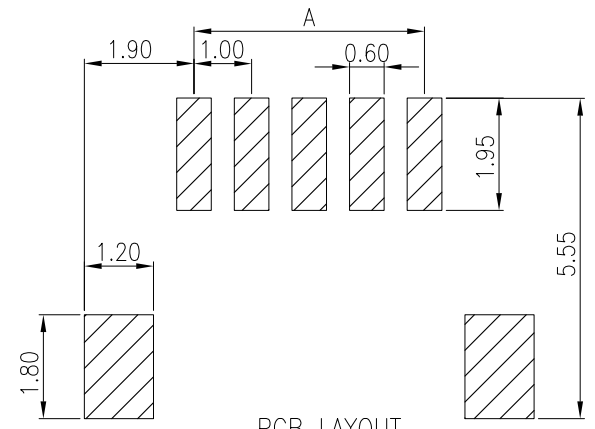

PCB LAYOUT  
Tolerance: ±0.05

Poles	A	B	C	D
2	1.00	4.50	2.60	3.60
3	2.00	5.50	3.60	4.60
4	3.00	6.50	4.60	5.60
5	4.00	7.50	5.60	6.60
6	5.00	8.50	6.60	7.60
7	6.00	9.50	7.60	8.60
8	7.00	10.50	8.60	9.60
9	8.00	11.50	9.60	10.60
10	9.00	12.50	10.60	11.60
11	10.00	13.50	11.60	12.60
12	11.00	14.50	12.60	13.60
13	12.00	15.50	13.60	14.60
14	13.00	16.50	14.60	15.60
15	14.00	17.50	15.60	16.60

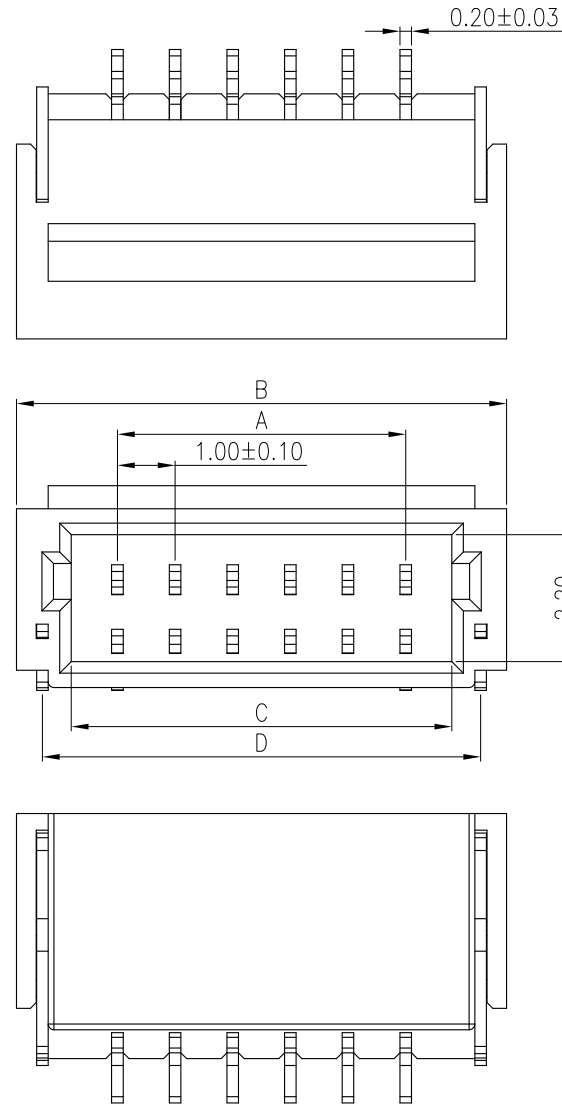
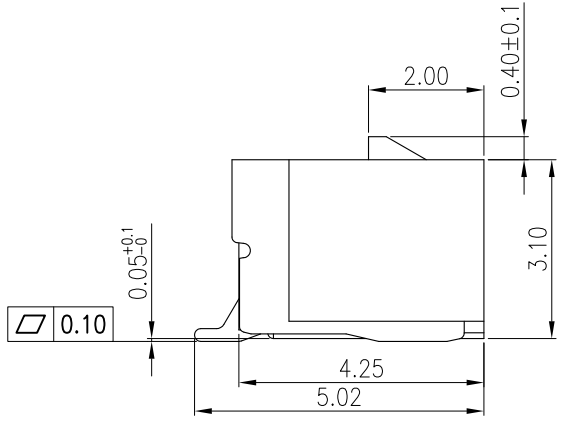

- NOTES:
- Material:  
Insulation: LCP, UL94V-0(Nature)  
Pin: Phosphor Bronze/Tin-Plated  
Tab: Phosphor Bronze/Tin-Plated
  - Current Rating: 1A AC,DC
  - Voltage Rating: 50V AC,DC
  - Temperature Rang: -25°C~+85°C
  - Contact Resistance: 20mΩ Max
  - Insulation Resistance: 100MΩ Min
  - Withstanding Voltage: 500V AC/minute
  - Ordering Code: A1000RSL-X

TOLERANCE  X. ±0.30 X.X ±0.25 X.XX ±0.20 Angle ±3°  UNLESS OTHERWISE SPECIFIED	APPROVALS		DATE	深圳市金航标电子有限公司		www.kinghelm.com.cn	
	DRAWN <i>Zhang Liao Tao</i>		01/10/18'	KH-A1000RSL-8P		0755-28190160	
	CHK'D <i>Art Shi</i>		01/10/18'	PART NO. A1000RSL-X		TITLE: WIRE TO BOARD, PLUG, PITCH 1.00mm, CRIMP TYPE, ASSEMBLY	
	APP'D <i>Art Shi</i>		01/10/18'	DRAWING NO. EN-A1000RSL-X			
	UNITS mm	SCALE 1:1	SIZE: A4		SHEET 1 OF 1	001	REV.A/0